

ASSEMBLY INSTRUCTION

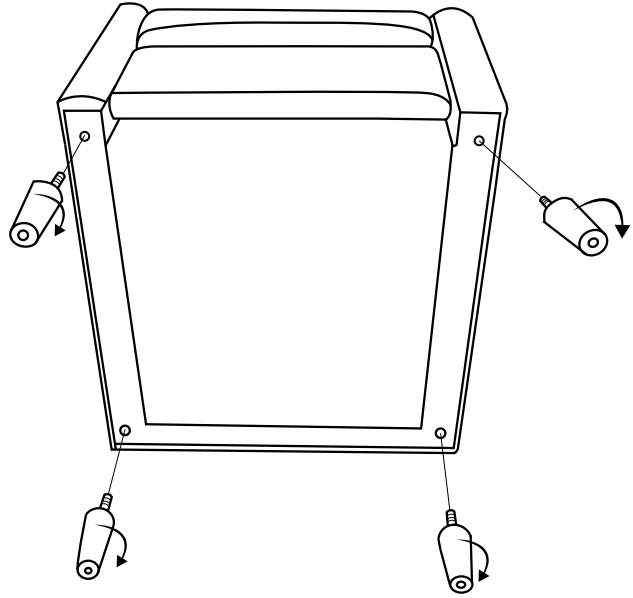

1 2

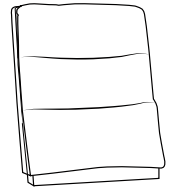
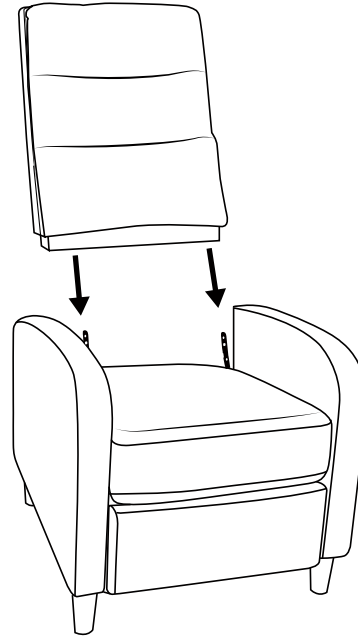

x1

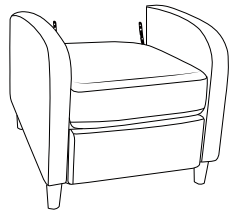

x1

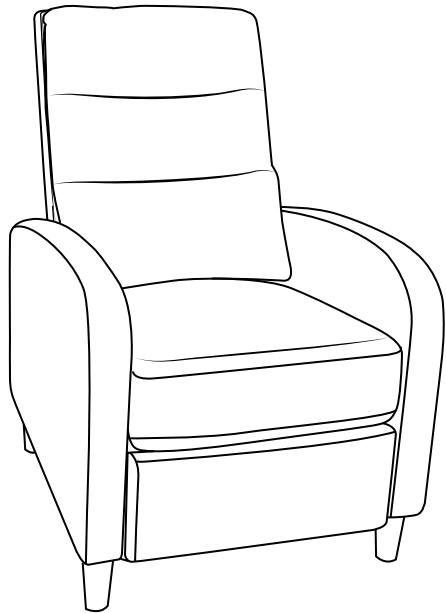

3 4

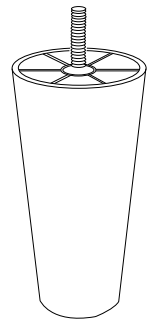
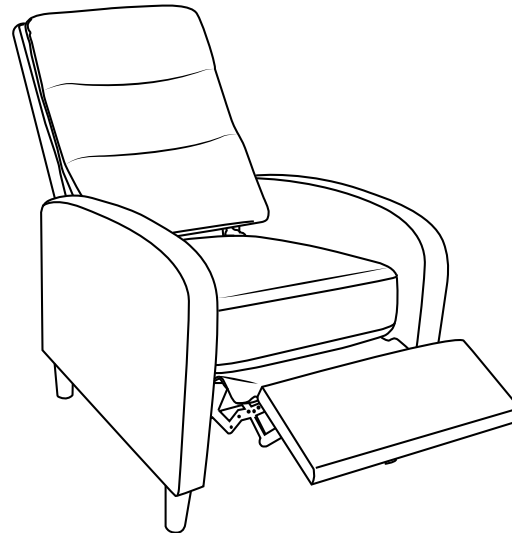

x4